



SINIS

IT +39 022 1117815
IT +39 335 7600875
EN/FR +39 3425447140
ES +34 664 66 64 26
ES +34 664 66 64 28
ES +34 661 102 712
ES +34 935 05 67 23

SINEDITALIA.IT
SINEDITALIA.ES
SINEDITALIA.FR
SINEDITALIA.COM
INFO@SINEDITALIA.COM

COLLEZIONE DOCCE DA INCASSO
SOLUZIONI DA INCASSO PER BAGNI INTERNI ED ESTERNI IN
ACCIAIO INOSSIDABILE 316L

BUILT-IN SHOWER COLLECTION
BUILT-IN SOLUTIONS FOR INDOOR AND OUTDOOR BATHROOMS IN 316L
STAINLESS STEEL

DOCCE DA PARETE IN ACCIAIO INOX NAUTICO 316L

WALL-MOUNTED SHOWERS IN 316L MARINE-GRADE STAINLESS STEEL



Docce in Acciaio Inox 316L – Solo Acqua Fredda o Premiscelata

La gamma di docce SINED in acciaio inox marino AISI 316L, dedicate all'uso con acqua fredda o premiscelata, rappresenta la linea più essenziale e accessibile dell'offerta outdoor.

Una collezione pensata per chi cerca funzionalità e resistenza, senza rinunciare allo stile e alla qualità che da sempre contraddistinguono il marchio.

Rispetto alle gamme dotate di miscelatori termostatici o funzioni avanzate, questa linea si distingue per una configurazione tecnica più semplice, ideale per contesti residenziali, giardini privati, terrazze o impianti con uso continuo.

Realizzate in acciaio inox AISI 316L – lo stesso impiegato in ambienti marini – queste docce garantiscono una lunga durata e una straordinaria resistenza alla corrosione e agli agenti atmosferici.

L'estetica è pulita, essenziale, con superfici satinata che valorizzano ambienti contemporanei e architetture all'aperto.

Tra i modelli principali, Nora e Teulada rispondono perfettamente alle esigenze di installazione rapida e uso quotidiano in ambienti privati o pubblici.

Il modello Santadi introduce una caratteristica in più: è predisposto per sistema a gettone, rendendolo la scelta ideale per spiagge, campeggi, piscine pubbliche e impianti sportivi.

In Italia, dove l'utilizzo delle docce a pagamento è una consuetudine diffusa, Santadi diventa un alleato efficiente e affidabile.

Questa gamma incarna lo spirito SINED: materiali nobili, funzionalità concrete, estetica minimale e un prezzo competitivo. Perfetta per chi desidera qualità e durata senza eccessi.

316L Stainless Steel Showers – Cold Water Only or Premixed

The SINED range of showers, crafted from AISI 316L marine-grade stainless steel and designed for use with cold or pre-mixed water, represents the most minimalist and affordable line in our outdoor range. This collection is designed for those seeking functionality and durability, without compromising on the style and quality that have always set the brand apart.

Compared to ranges featuring thermostatic mixers or advanced functions, this line stands out for its simpler technical configuration, making it ideal for residential settings, private gardens, terraces or installations requiring continuous use. Crafted from AISI 316L stainless steel – the same grade used in marine environments – these showers guarantee a long service life and exceptional resistance to corrosion and the elements. The design is clean and minimalist, with satin-finished surfaces that enhance contemporary interiors and outdoor architecture.

Among the main models, Nora and Teulada are perfectly suited to the requirements of quick installation and everyday use in both private and public settings. The Santadi model offers an additional feature: it is designed for coin-operated systems, making it the ideal choice for beaches, campsites, public swimming pools and sports facilities. In Italy, where the use of pay-to-use showers is widespread, Santadi proves to be an efficient and reliable solution.

This range embodies the SINED spirit: high-quality materials, practical functionality, minimalist design and a competitive price. Perfect for those who want quality and durability without the frills.

Design libero, resistenza totale

Le docce a parete SINED in acciaio inossidabile AISI 316L, come i modelli ARBOREA e CHIA PARETE, offrono una soluzione resistente e versatile per ambienti esterni particolarmente esigenti. Il loro design senza soffione consente di personalizzare l'installazione con diversi tipi di ugelli, adattandosi a ogni progetto con totale libertà. Ideali per ambienti quali piscine, giardini o zone costiere, combinano durata, estetica minimalista e facile integrazione architettonica.

Unrestricted design, total durability

SINED wall-mounted showers in AISI 316L stainless steel, such as the ARBOREA and CHIA PARETE models, offer a durable and versatile solution for particularly demanding outdoor environments. Their showerhead-free design allows for customisation with different types of nozzles, adapting to any project with complete freedom. Ideal for environments such as swimming pools, gardens or coastal areas, they combine durability, minimalist aesthetics and easy architectural integration.



Docce da parete acciaio inox 316L senza soffione *316L stainless steel wall-mounted showers without a shower*



DOCCIA-ARBOREA



INOX



NERO
PVD



DOCCIA-CHIA-PARETE



INOX



NERO
PVD

DOCCIA-ARBOREA

STOCK

 INOX 8025431018600

PVD  NERA 8025431150935



CARATTERISTICHE

- **MATERIALE ACCIAIO INOX 316L / 316L STAINLESS STEEL**
- **UGELLI ANTICALCARE / ANTI LIMESCALE NOZZLES**
- **ACCESSORI IN ACCIAIO INOX 316L / STAINLESS STEEL 316L**
- **PESO/WEIGHT 8 KG**
- **PACKAGING 102X62X18 CM**
- **CERTIFICATED FOR INDOOR AND OUTDOOR**
- **INCLUDES SACCA PROTEZIONE/ PROTECTION BAG**
- **MISCELATORE/MIXER UNICO CON CARTUCCIA PROGRESSIVA A 3 VIE/WAY CHE REGOLA:**
 - INTENSITÀ DEL GETTO / JET INTENSITY
 - TEMPERATURA CALDA-FREDDA / HOT-COLD
 - DIREZIONE DELL'ACQUA/DIRECTION OF WATER
- **GETTO D'ACQUA / WATER JET VERTICAL**
- **PARTE ORIZZONTALE NON REVERSIBILE, MONTAGGIO SOLO A DESTRA / NON-REVERSIBLE HORIZONTAL SECTION, RIGHT-SIDE MOUNTING ONLY**
- **CONNESSIONE ACQUA CALDA IN ENTRATA LATO SINISTRO / HOT WATER CONNECTION ON THE LEFT SIDE**
- **ACQUA CALDA E FREDDA / WATER HOT AND COLD**

FIXING SYSTEM WITH 3 POINTS

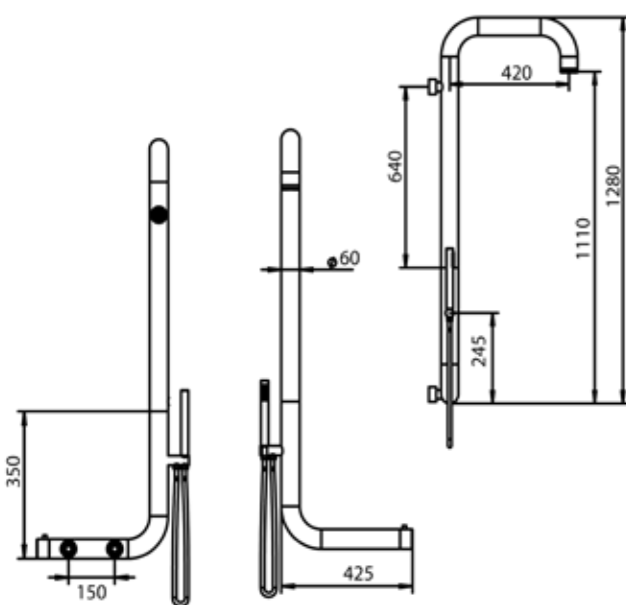
*WATCH VIDEO OF THE ASSEMBLY



finiture/finishes	IVA esclusa / VAT excluded	IVA inclusa / VAT included
INOX 	1.228,69€	1.499€
NERO  PVD	1.598,36€	1.950€

DOCCIA-CHIA-PARETE

STOCK

 INOX 8025431153028

PVD  NERA 8025431153035

CARATTERISTICHE

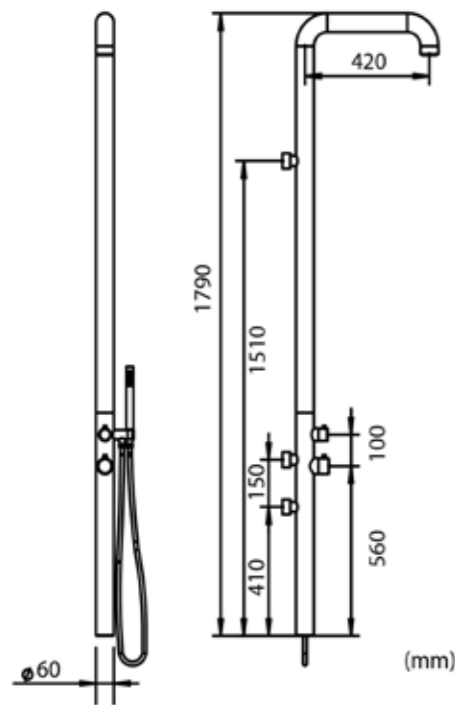

- **MATERIALE ACCIAIO INOX 316L / 316L STAINLESS STEEL**
- **UGELLI ANTICALCARE / ANTI LIMESCALE NOZZLES**
- **ACCESSORI IN ACCIAIO INOX 316L / STAINLESS STEEL 316L**
- **PESO/WEIGHT 10 KG**
- **PACKAGING 120X582X20 CM**
- **CERTIFICATED FOR INDOOR AND OUTDOOR**
- **INCLUDES SACCA PROTEZIONE/ PROTECTION BAG**
- **IL DEVIATORE CONTROLLA LA DIREZIONE DELL'ACQUA E CONSENTE DI CHIUDERE IL FLUSSO / THE DIVERTER CONTROLS THE DIRECTION OF THE WATER AND ALLOWS THE FLOW TO BE SHUT OFF.**
- **IL MISCELATORE REGOLA LA TEMPERATURA DELL'ACQUA / THE MIXER REGULATES THE WATER TEMPERATURE**
- **CONNESSIONE ACQUA CALDA IN ENTRATA LATO SUPERIORE / HOT WATER CONNECTION ON THE TOP SIDE**
- **GETTO D'ACQUA / WATER JET VERTICAL**
- **CONNESSIONI IN INGRESSO VERTICALI DISTANZA 15CM VERTICAL INPUT CONNECTIONS, DISTANCE 15 CM**
- **ACQUA CALDA E FREDDA / WATER HOT AND COLD**



FIXING SYSTEM WITH 3 POINTS

*WATCH VIDEO OF THE ASSEMBLY



finiture/finishes	IVA esclusa / VAT excluded	IVA inclusa / VAT included
INOX 	1.352,46€	1.650€
NERO  PVD	1.720,49€	2.099€

Soluzione completa, design impeccabile

Le docce a parete SINED in acciaio inossidabile AISI 316L con soffione integrato offrono una soluzione completa e pronta per l'installazione in ambienti esterni. Progettate per garantire la massima resistenza in contesti difficili, combinano la robustezza dell'acciaio nautico con un design elegante e funzionale. Il soffione incorporato offre un'esperienza d'uso immediata ed equilibrata, rendendole una scelta pratica, durevole ed esteticamente coerente per progetti residenziali e contract.

A complete solution with impeccable design

SINED wall-mounted showers in AISI 316L stainless steel with an integrated shower head offer a complete, ready-to-install solution for outdoor environments. Designed to ensure maximum durability in challenging conditions, they combine the robustness of marine-grade steel with an elegant and functional design. The built-in shower head provides an immediate and balanced user experience, making them a practical, durable and aesthetically consistent choice for residential and contract projects.



Docce da parete acciaio inox 316L con soffione 316L stainless steel wall-mounted showers with shower head



**PARETE
LEVANTE**



INOX ORO
ROSA

**LEVANTE
TERMOSTATICA**



INOX NERO
CANNA ORO
FUCILE ROSA



ORO

CABRAS



INOX NERO

PULA PARETE



INOX NERO

DOCCIA-PARETE-LEVANTE



STOCK



 INOX 8025431155909

PVD  ORO-ROSA 8025431156234

CARATTERISTICHE

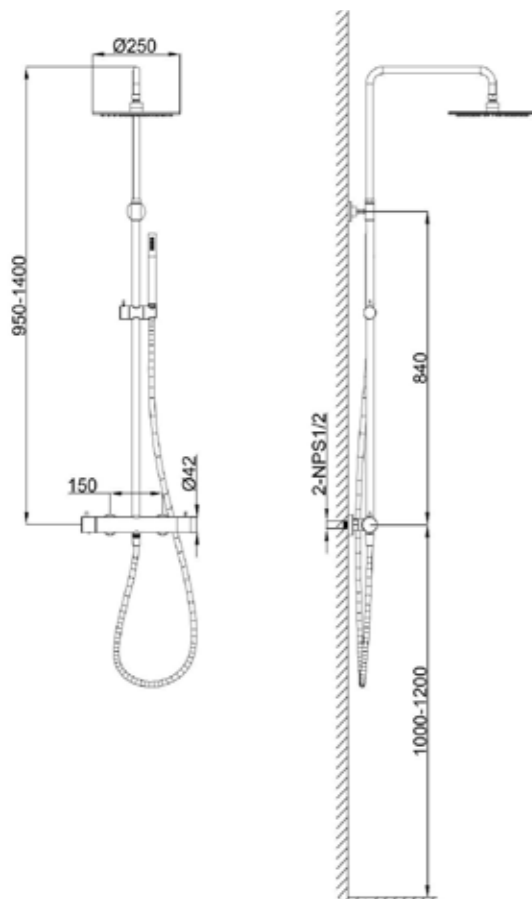
- **MATERIALE ACCIAIO INOX 316L / 316L STAINLESS STEEL**
- **UGELLI ANTICALCARE / ANTI LIMESCALE NOZZLES**
- **ACCESSORI IN ACCIAIO INOX 316L / STAINLESS STEEL 316L**
- **PESO/WEIGHT 8 KG**
- **PACKAGING 102X62X18 CM**
- **INSTALLATION WITH 3 FIXING POINTS**
- **CERTIFICATED FOR INDOOR AND OUTDOOR**
- **CONNESSIONE ACQUA CALDA IN ENTRATA LATO SINISTRO / HOT WATER CONNECTION ON THE LEFT SIDE**
- **IL DEVIATORE CONTROLLA LA DIREZIONE DELL'ACQUA E CONSENTE DI CHIUDERE IL FLUSSO / THE DIVERTER CONTROLS THE DIRECTION OF THE WATER AND ALLOWS THE FLOW TO BE SHUT OFF.**
- **IL MISCELATORE REGOLA LA TEMPERATURA DELL'ACQUA / THE MIXER REGULATES THE WATER TEMPERATURE**
- **ACQUA CALDA E FREDDA / WATER HOT AND COLD**



finiture/finishes	IVA esclusa / VAT excluded	IVA inclusa / VAT included
INOX 	736,89€	899€
ORO ROSA  PVD	941,8€	1.149€

DOCCIA-PARETE-LEVANTE-TERMOSTATICA





STOCK

 **INOX** 8025431155916

PVD  **CANNA-FUCILE** 8025431157903

PVD  **ORO-ROSA** 8025431156241

PVD  **NERA** 8025431157927 *

PVD  **ORO** 8025431157910 *





*DISPONIBILE SOLO SU ORDINAZIONE

*AVAILABLE ONLY UPON REQUEST

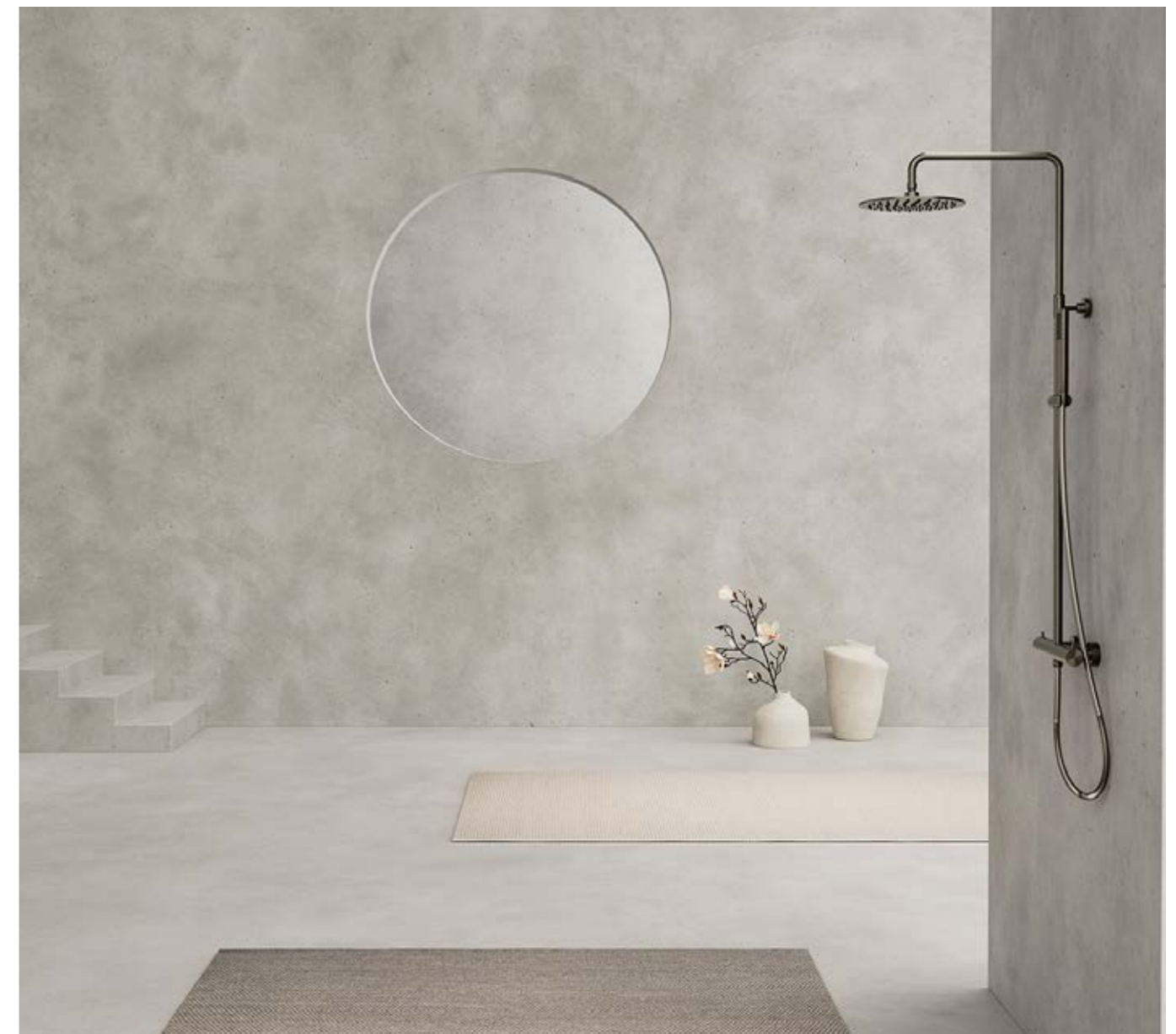
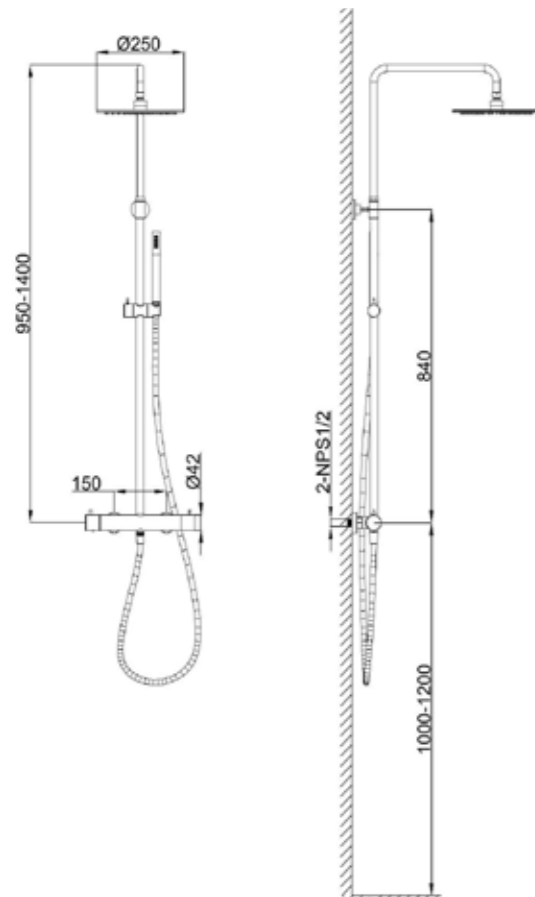
CARATTERISTICHE

- **MATERIALE ACCIAIO INOX 316L / 316L STAINLESS STEEL**
- **UGELLI ANTICALCARE / ANTI LIMESCALE NOZZLES**
- **ACCESSORI IN ACCIAIO INOX 316L / STAINLESS STEEL 316L**
- **PESO/WEIGHT 8 KG**
- **PACKAGING 102X62X18 CM**
- **CERTIFICATED FOR INDOOR AND OUTDOOR**
- **IL DEVIATORE CONTROLLA LA DIREZIONE DELL'ACQUA E CONSENTE DI CHIUDERE IL FLUSSO / THE DIVERTER CONTROLS THE DIRECTION OF THE WATER AND ALLOWS THE FLOW TO BE SHUT OFF.**
- **IL MISCELATORE REGOLA LA TEMPERATURA DELL'ACQUA / THE MIXER REGULATES THE WATER TEMPERATURE**
- **CONNESSIONE ACQUA CALDA IN ENTRATA LATO SINISTRO / HOT WATER CONNECTION ON THE LEFT SIDE**
- **GETTO D'ACQUA / WATER JET VERTICAL**
- **CARTUCCIA TERMOSTATICA VERNET SPECIFICA PER IL MODELLO LEVANTE-TERMOSTATICA**
- **ACQUA CALDA E FREDDA / WATER HOT AND COLD**





finiture/finishes	IVA esclusa / VAT excluded	IVA inclusa / VAT included
INOX 	786,07€	959€
CANNA FUCILE  PVD	1.023,77€	1.249€
ORO ROSA  PVD	1.023,77€	1.249€
ORO*  PVD	1.023,77€	1.249€
NERO*  PVD	1.023,77€	1.249€

* Disponibile solo su richiesta / Available only upon request

DOCCIA-CABRAS

STOCK

 **INOX** 8025431153080

PVD  **NERA** 8025431153097



CARATTERISTICHE

- **MATERIALE ACCIAIO INOX 316L / 316L STAINLESS STEEL**
- **UGELLI ANTICALCARE / ANTI LIMESCALE NOZZLES**
- **ACCESSORI IN ACCIAIO INOX 316L / STAINLESS STEEL 316L**
- **PESO/WEIGHT 8 KG**
- **PACKAGING 102X62X18 CM**
- **CERTIFICATED FOR INDOOR AND OUTDOOR**
- **INCLUDES SACCA PROTEZIONE/ PROTECTION BAG**
- **MISCELATORE/MIXER UNICO CON CARTUCCIA PROGRESSIVA A 3 VIE/WAY CHE REGOLA:**
 - INTENSITÀ DEL GETTO / JET INTENSITY
 - TEMPERATURA CALDA-FREDDA / HOT-COLD
 - DIREZIONE DELL'ACQUA/DIRECTION OF WATER
- **GETTO D'ACQUA / WATER JET VERTICAL**
- **PARTE ORIZZONTALE NON REVERSIBILE, MONTAGGIO SOLO A DESTRA / NON-REVERSIBLE HORIZONTAL SECTION, RIGHT-SIDE MOUNTING ONLY**
- **CONNESSIONE ACQUA CALDA IN ENTRATA LATO SINISTRO / HOT WATER CONNECTION ON THE LEFT SIDE**
- **ACQUA CALDA E FREDDA / WATER HOT AND COLD**

FIXING SYSTEM WITH 3 POINTS

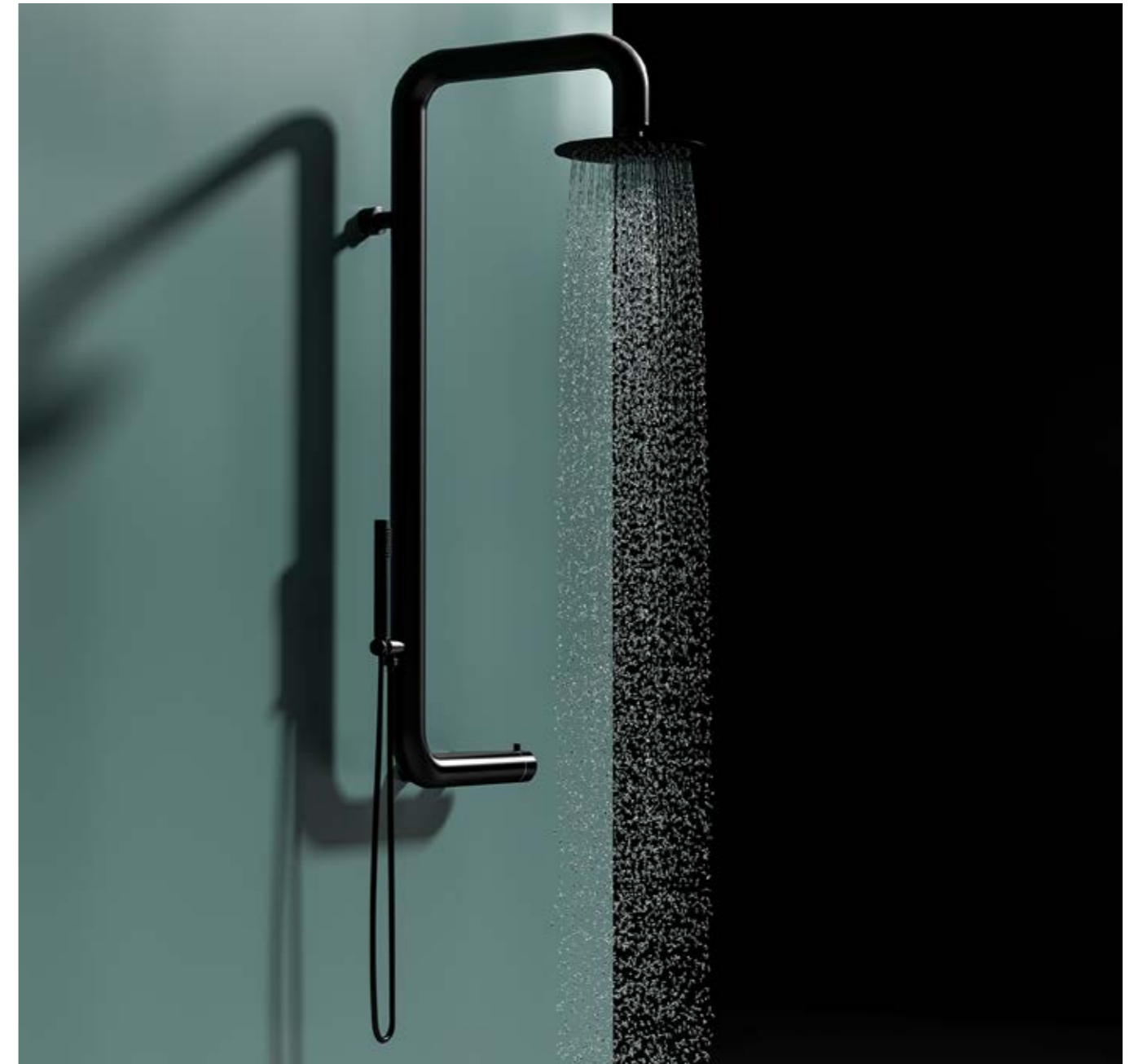
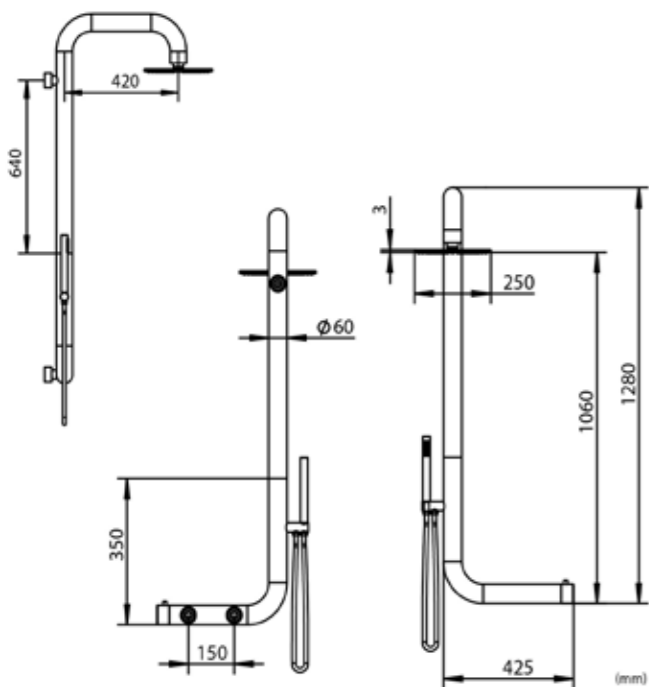
*WATCH VIDEO OF THE ASSEMBLY



finiture/finishes	IVA esclusa / VAT excluded	IVA inclusa / VAT included
INOX 	1.352,46€	1.650€
NERO  PVD	1.720,49€	2.099€

DOCCIA-PULA-PARETE

STOCK

 INOX 8025431153004

PVD  NERA 8025431153011



CARATTERISTICHE

- **MATERIALE ACCIAIO INOX 316L / 316L STAINLESS STEEL**
- **UGELLI ANTICALCARE / ANTI LIMESCALE NOZZLES**
- **ACCESSORI IN ACCIAIO INOX 316L / STAINLESS STEEL 316L**
- **PESO/WEIGHT 10 KG**
- **PACKAGING 125X58X20 CM**
- **CERTIFICATED FOR INDOOR AND OUTDOOR**
- **INCLUDES SACCA PROTEZIONE/ PROTECTION BAG**
- **IL DEVIATORE CONTROLLA LA DIREZIONE DELL'ACQUA E CONSENTE DI CHIUDERE IL FLUSSO / THE DIVERTER CONTROLS THE DIRECTION OF THE WATER AND ALLOWS THE FLOW TO BE SHUT OFF.**
- **IL MISCELATORE REGOLA LA TEMPERATURA DELL'ACQUA / THE MIXER REGULATES THE WATER TEMPERATURE**
- **CONNESSIONE ACQUA CALDA IN ENTRATA LATO SUPERIORE / HOT WATER CONNECTION ON THE TOP SIDE**
- **GETTO D'ACQUA / WATER JET VERTICAL**
- **CONNESSIONI IN INGRESSO VERTICALI DISTANZA 15CM VERTICAL INPUT CONNECTIONS, DISTANCE 15 CM**
- **ACQUA CALDA E FREDDA / WATER HOT AND COLD**

FIXING SYSTEM WITH 3 POINTS

*WATCH VIDEO OF THE ASSEMBLY



finiture/finishes	IVA esclusa / VAT excluded	IVA inclusa / VAT included
INOX 	1.474,59€	1.799€
NERO  PVD	1.762,3€	2.150€

SOFFIONI E DOCCINI PER DOCCIA IN ACCIAIO INOX NAUTICO 316L

316L MARINE-GRADE STAINLESS STEEL SHOWER HEADS AND HAND SHOWERS



Soffioni e doccette SINED

I soffioni e le doccette manuali SINED in acciaio inossidabile AISI 316L sono progettati per offrire un'esperienza doccia di alto livello in ambienti esterni, coniugando funzionalità, resistenza ed estetica. Realizzati in acciaio inossidabile nautico, garantiscono un'eccellente resistenza alla corrosione, anche in ambienti marini o altamente esposti.

Disponibili in diversi formati — dai grandi soffioni superiori alle soluzioni con doccetta più versatili— consentono di adattare ogni installazione alle esigenze dello spazio e dell'utente. Il loro design curato e contemporaneo si integra facilmente in progetti sia residenziali che contract, garantendo coerenza estetica e qualità percepita.

Progettati per un uso intensivo e una manutenzione minima, questi elementi completano qualsiasi sistema doccia SINED con affidabilità, precisione e una sensazione di comfort costante ad ogni utilizzo.

SINED shower heads and hand showers

SINED shower heads and hand showers, crafted from AISI 316L stainless steel, are designed to deliver a premium showering experience in outdoor settings, combining functionality, durability and aesthetic appeal. Made from marine-grade stainless steel, they offer excellent resistance to corrosion, even in marine environments or areas subject to high exposure.

Available in a range of styles — from large overhead shower heads to more versatile hand shower solutions — they allow each installation to be tailored to the specific requirements of the space and the user. Their refined, contemporary design blends seamlessly into both residential and commercial projects, ensuring aesthetic consistency and a high-quality feel.

Designed for heavy-duty use and minimal maintenance, these components complement any SINED shower system with reliability, precision and a consistent sense of comfort every time they are used.

Versatilità e controllo in ogni dettaglio

I sistemi doccia a mano in acciaio inox AISI 316L di SINED offrono una soluzione pratica e resistente per ambienti esterni ed interni. Progettati per garantire massima durata e facilità d'uso, combinano design essenziale e funzionalità, permettendo un controllo preciso del flusso d'acqua e una perfetta integrazione in qualsiasi spazio bagno o outdoor.

Versatility and control in every detail

SINED's AISI 316L stainless steel hand-held shower systems offer a practical and durable solution for both indoor and outdoor use. Designed to ensure maximum durability and ease of use, they combine minimalist design with functionality, allowing for precise control of the water flow and seamless integration into any bathroom or outdoor space.



Sistema doccia a mano in acciaio inox 316L 316L stainless steel hand shower system



**DOCCETTA
FLESSIBILE MURO
LEVANTE**



INOX NERO*

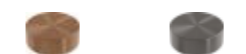

ORO ROSA CANNA FUCILE

**SET DOCCINO
FLESSIBILE
WATER**

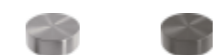

INOX CANNA FUCILE



ORO ROSA

**SET DOCCINO
FLESSIBILE
SHATTAF**



INOX CANNA FUCILE



ORO ROSA

**SET MISCELATORE
ATTACCO
DOCCINO**



INOX CANNA FUCILE



ORO ROSA

* Disponibile solo su richiesta

* Available only upon request



**KIT RUBINETTO
LAVANDINO
LEVANTE PARETE**



INOX CANNA FUCILE ORO ROSA

DOCCETTA-FLESSIBILE-MURO-LEVANTE

STOCK

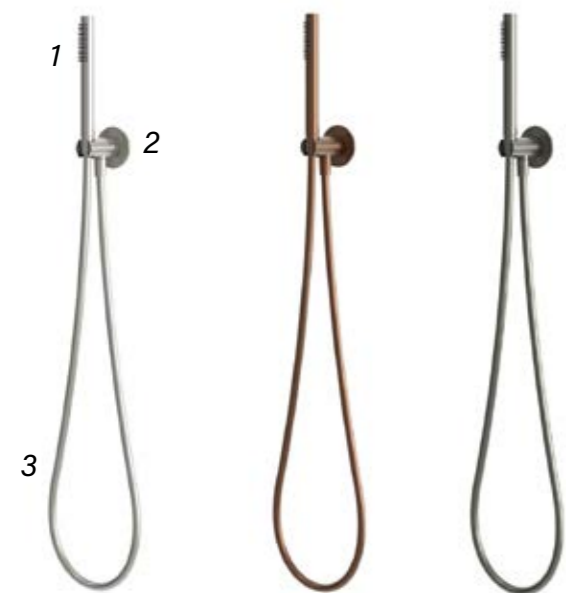

 **INOX** 8025431155923

PVD  **ORO-ROSA** 8025431156203

PVD  **CANNA-FUCILE** 8025431159334

PVD  **NERA** 8025431020221 *





*DISPONIBILE SOLO SU ORDINAZIONE

*AVAILABLE ONLY UPON REQUEST

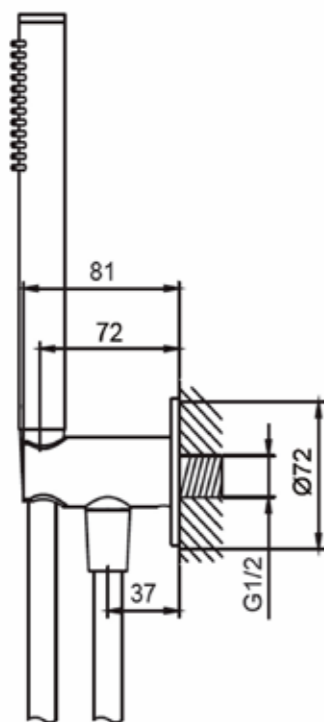
CARATTERISTICHE

- **MATERIALE ACCIAIO INOX 316L / 316L STAINLESS STEEL**
- **DOCCETTA CON GETTO PIOGGIA**
HAND SHOWER WITH RAIN JET
- **COLLEGAMENTO A MURO**
WALL-MOUNTED CONNECTION
- **CORPO INCASSO INCLUSO**
WALL RECESSED BODY INCLUDED
- **COMPLETAMENTE PRIVO DI PIOMBO**
COMPLETELY LEAD-FREE
- **COMPONENTI KIT**
 1. DOCCINO-LEVANTE
 2. SUPPORTO-MURO-DOCCINO-LEVANTE
 3. TUBO-FLESSIBILE-LEVANTE-INOX
- **PARTICOLARMENTE ADATTO PER AMBIENTI AD ALTO UTILIZZO O IN PROSSIMITÀ DEL MARE**
PARTICULARLY SUITABLE FOR HIGH-USE ENVIRONMENTS AND COASTAL AERAS
- **IDEALE PER STRUTTURE COME HOTEL, PISCINE PUBBLICHE, PALESTRE, AEROPORTI O BAGNI DI LOCALI CHE RICEVONO UN GRANDE FLUSSO DI UTENTI OGNI GIORNO**
IDEAL FOR FACILITIES SUCH AS HOTELS, PUBLIC POOLS, GYMS, AIRPORTS, AND HIGH-TRAFFIC RESTROOMS EXPERIENCE CONSTANT DAILY USE



finiture/finishes	IVA esclusa / VAT excluded	IVA inclusa / VAT included
INOX 	109,02€	133€
CANNA FUCILE  PVD	145,07€	176,99€
ORO ROSA  PVD	145,07€	176,99€
NERO*  PVD	145,07€	176,99€

* Disponibile solo su richiesta / Available only upon request

SET-DOCCINO-FLESSIBILE-WATER



STOCK

 INOX 8025431155947

PVD  ORO-ROSA 8025431156531



PVD  CANNA-FUCILE 8025431159358

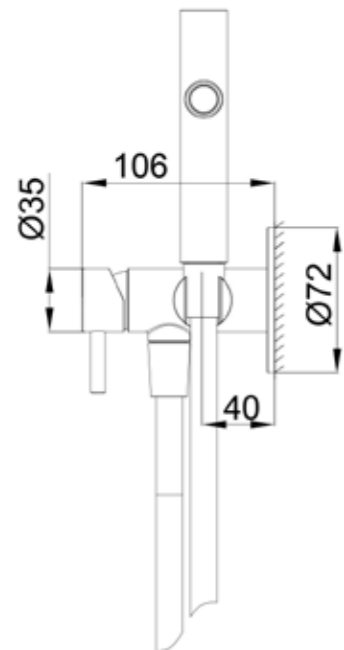

CARATTERISTICHE

- **MATERIALE ACCIAIO INOX 316L / 316L STAINLESS STEEL**
- **SET DOCCETTA SHATTAF PER WC E BIDET**
SHATTAFF HAND SHOWER SET FOR WC AND BIDET
- **DOCCETTA CON PULSANTE**
PUSH-BUTTON HAND SHOWER
- **COLLEGAMENTO A MURO**
WALL CONNECTION
- **COMPLETAMENTE PRIVO DI PIOMBO**
COMPLETELY LEAD-FREE
- **CORPO INCASSO INCLUSO**
WALL RECESSED BODY INCLUDED
- **COMPONENTI KIT**
 1. *DOCCETTA-WATER-LEVANTE*
 2. *ATTACCO-MURO-DOCCINO-LEVANTE*
 3. *TUBO-FLESSIBILE-LEVANTE-INOX*
 4. *MISCELATORE-MURO-ATTACCO-SHATTAF*
- **PARTICOLARMENTE ADATTO PER AMBIENTI AD ALTO UTILIZZO O IN PROSSIMITÀ DEL MARE**
PARTICULARLY SUITABLE FOR HIGH-USE ENVIRONMENTS AND COASTAL AERAS
- **IDEALE PER STRUTTURE COME HOTEL, PISCINE PUBBLICHE, PALESTRE, AEROPORTI O BAGNI DI LOCALI CHE RICEVONO UN GRANDE FLUSSO DI UTENTI OGNI GIORNO**
IDEAL FOR FACILITIES SUCH AS HOTELS, PUBLIC POOLS, GYMS, AIRPORTS, AND HIGH-TRAFFIC RESTROOMS EXPERIENCE CONSTANT DAILY USE



finiture/finishes	IVA esclusa / VAT excluded	IVA inclusa / VAT included
INOX 	198,36€	242€
CANNA FUCILE  PVD	258,2€	315€
ORO ROSA  PVD	258,2€	315€

KIT-RUBINETTO-LAVANDINO-LEVANTE-PARETE

STOCK



 **INOX** 8025431155688

PVD  **ORO-ROSA** 8025431156258

PVD  **CANNA-FUCILE** 8025431159426



CARATTERISTICHE

- **MATERIALE ACCIAIO INOX 316L / 316L STAINLESS STEEL**
- **INSTALLAZIONE A INCASSO CON BOX NASCOSTO**
CONCEALED INSTALLATION WITH HIDDEN BOX
- **GETTO AERATO, DELICATO E SENZA SCHIZZI**
AERATED, GENTLE AND SPLASH-FREE WATER FLOW
- **MISCELATORE A PARETE DA INCASSO**
WALL-MOUNTED BUILT-IN MIXER
- **CORPO INCASSO INCLUSO**
WALL RECESSED BODY INCLUDED
- **ACQUA CALDA E FREDDA**
HOT AND COLD WATER
- **COMPLETAMENTE PRIVO DI PIOMBO**
COMPLETELY LEAD-FREE
- **COMPONENTI KIT**
 1. *BOCCHETTA-PARETE-LEVANTE*
 2. *MISCELATORE-MURO-LEVANTE*

- **PARTICOLARMENTE ADATTO PER AMBIENTI AD ALTO UTILIZZO O IN PROSSIMITÀ DEL MARE**
PARTICULARLY SUITABLE FOR HIGH-USE ENVIRONMENTS AND COASTAL AREAS

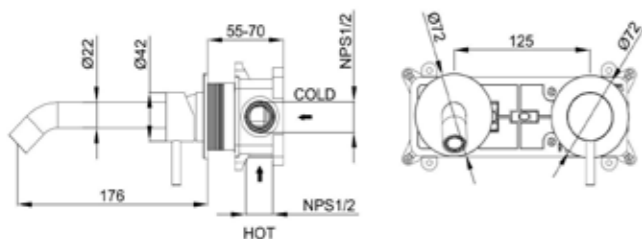
- **IDEALE PER STRUTTURE COME HOTEL, PISCINE PUBBLICHE, PALESTRE, AEROPORTI O BAGNI DI LOCALI CHE RICEVONO UN GRANDE FLUSSO DI UTENTI OGNI GIORNO**
IDEAL FOR FACILITIES SUCH AS HOTELS, PUBLIC POOLS, GYMS, AIRPORTS, AND HIGH-TRAFFIC RESTROOMS EXPERIENCE CONSTANT DAILY USE



finiture/finishes	IVA esclusa / VAT excluded	IVA inclusa / VAT included
INOX 	219,66€	268€
CANNA FUCILE  PVD	285,25€	348€
ORO ROSA  PVD	285,25€	348€

SET-MISCELATORE-ATTACCO-DOCCINO



STOCK

 INOX 8025431020085



PVD  ORO-ROSA 8025431020092

PVD  CANNA-FUCILE 8025431020108

CARATTERISTICHE

- **MATERIALE ACCIAIO INOX 316L / 316L STAINLESS STEEL**
- **SET DOCCINO CON MISCELATORE DA PARETE / HAND SHOWER SET WITH WALL-MOUNTED MIXER**
- **DOCCETTA CON UGELLI IN SILICONE ANTICALCARE/ HAND SHOWER WITH LIMESCALE-RESISTANT SILICONE NOZZLES**
- **COLLEGAMENTO A MURO WALL CONNECTION**
- **COMPLETAMENTE PRIVO DI PIOMBO COMPLETELY LEAD-FREE**
- **CORPO INCASSO INCLUSO WALL RECESSED BODY INCLUDED**
- **COMPONENTI KIT**
 1. DOCCINO-LEVANTE
 2. TUBO-FLESSIBILE-LEVANTE-INOX
 3. MISCELATORE-MURO-DOCCINO-LEVANTE
- **PARTICOLARMENTE ADATTO PER AMBIENTI AD ALTO UTILIZZO O IN PROSSIMITÀ DEL MARE PARTICULARLY SUITABLE FOR HIGH-USE ENVIRONMENTS AND COASTAL AERAS**
- **IDEALE PER STRUTTURE COME HOTEL, PISCINE PUBBLICHE, PALESTRE, AEROPORTI O BAGNI DI LOCALI CHE RICEVONO UN GRANDE FLUSSO DI UTENTI OGNI GIORNO IDEAL FOR FACILITIES SUCH AS HOTELS, PUBLIC POOLS, GYMS, AIRPORTS, AND HIGH-TRAFFIC RESTROOMS EXPERIENCE CONSTANT DAILY USE**



finiture/finishes	IVA esclusa / VAT excluded	IVA inclusa / VAT included
INOX 	387,7€	472,99€
CANNA FUCILE  PVD	505,74€	617€
ORO ROSA  PVD	505,74€	617€

SET-DOCCINO-FLESSIBILE-SHATTAF



STOCK

 INOX 8025431020368



PVD  ORO-ROSA 8025431020382

PVD  CANNA-FUCILE 8025431020375

CARATTERISTICHE

- **MATERIALE ACCIAIO INOX 316L / 316L STAINLESS STEEL**
- **SET DOCCETTA SHATTAF PER WC E BIDET**
SHATTAF HAND SHOWER SET FOR WC AND BIDET
- **DOCCETTA BIDET TIPO SHATTAF / SHATTAF-STYLE**
BIDET HAND SHOWER
- **COLLEGAMENTO A MURO**
WALL CONNECTION
- **COMPLETAMENTE PRIVO DI PIOMBO**
COMPLETELY LEAD-FREE
- **CORPO INCASSO INCLUSO**
WALL RECESSED BODY INCLUDED
- **COMPONENTI KIT**
 1. SHATTAF-BIDET-LEVANTE
 2. ATTACCO-MURO-DOCCINO-LEVANTE
 3. TUBO-FLESSIBILE-LEVANTE-INOX
 4. MISCELATORE-MURO-ATTACCO-SHATTAF
- **PARTICOLARMENTE ADATTO PER AMBIENTI AD ALTO UTILIZZO O IN PROSSIMITÀ DEL MARE**
PARTICULARLY SUITABLE FOR HIGH-USE ENVIRONMENTS AND COASTAL AERAS
- **IDEALE PER STRUTTURE COME HOTEL, PISCINE PUBBLICHE, PALESTRE, AEROPORTI O BAGNI DI LOCALI CHE RICEVONO UN GRANDE FLUSSO DI UTENTI OGNI GIORNO**
IDEAL FOR FACILITIES SUCH AS HOTELS, PUBLIC POOLS, GYMS, AIRPORTS, AND HIGH-TRAFFIC RESTROOMS EXPERIENCE CONSTANT DAILY USE



finiture/finishes	IVA esclusa / VAT excluded	IVA inclusa / VAT included
INOX 	455,74€	556€
CANNA FUCILE  PVD	504,91€	615,99€
ORO ROSA  PVD	504,91€	615,99€

Kit doccia soffitto/parete in acciaio inox 316L 316L stainless steel ceiling/wall shower kit

Soluzioni complete per un'esperienza superiore

I kit soffioni SINED, sia da soffitto che da parete, sono progettati per offrire una soluzione completa ed elegante in acciaio inox AISI 316L. Pensati per garantire resistenza, durabilità e prestazioni ottimali, integrano tutti gli elementi necessari per un'installazione semplice e un risultato estetico impeccabile. Il loro design moderno e funzionale li rende ideali per progetti che richiedono comfort, qualità e coerenza in ogni dettaglio.

Comprehensive solutions for a superior experience

SINED shower head kits, available in both ceiling-mounted and wall-mounted versions, are designed to offer a complete and elegant solution crafted from AISI 316L stainless steel. Engineered to ensure strength, durability and optimal performance, they include all the components needed for straightforward installation and a flawless aesthetic finish. Their modern and functional design makes them ideal for projects that demand comfort, quality and consistency in every detail.



KIT-SOFFITTO-SOFFIONE-LEVANTE-CORTO-25

STOCK Ø25



 **INOX** 8025431155824



PVD  **ORO-ROSA** 8025431156876

PVD  **CANNA-FUCILE** 8025431159433

CARATTERISTICHE

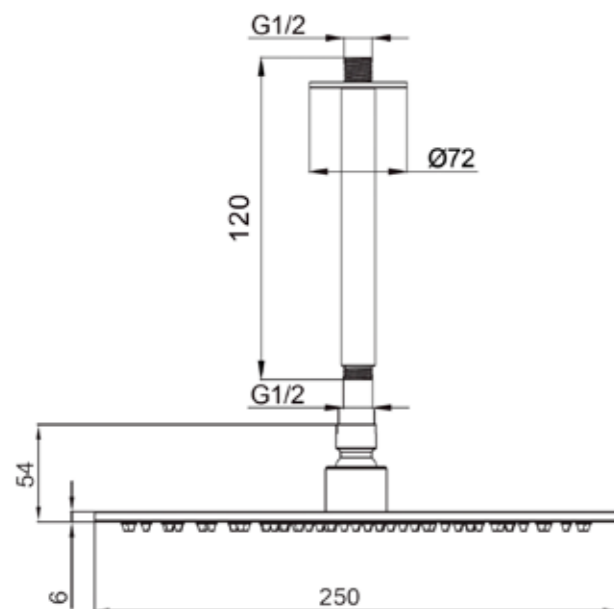
- **MATERIALE ACCIAIO INOX 316L / 316L STAINLESS STEEL**
- **KIT DOCCIA A SOFFITTO CON SOFFIONE Ø25CM**
CEILING SHOWER SET WITH Ø25CM SHOWER HEAD
- **ADATTO AD AMBIENTI AD ALTA ESPOSIZIONE**
SUITABLE FOR HIGH-EXPOSURE AREAS
- **BORDO RINFORZATO SPESSORE 6 MM**
REINFORCED EDGE, 6 MM THICKNESS
- **UGELLI IN SILICONE ANTICALCARE**
ANTI-LIME SILICONE NOZZLES
- **COMPLETAMENTE PRIVO DI PIOMBO**
COMPLETELY LEAD-FREE
- **COMPONENTI KIT**
 1. BRACCIO-DOCCIA-SOFFITTO-LEVANTE-CORTO
 2. SOFFIONE-LEVANTE-25
- **IDEALE PER STRUTTURE COME HOTEL, PISCINE PUBBLICHE, PALESTRE, AEROPORTI O BAGNI DI LOCALI CHE RICEVONO UN GRANDE FLUSSO DI UTENTI OGNI GIORNO**
IDEAL FOR FACILITIES SUCH AS HOTELS, PUBLIC POOLS, GYMS, AIRPORTS, AND HIGH-TRAFFIC RESTROOMS EXPERIENCE CONSTANT DAILY USE



finiture/finishes	IVA esclusa / VAT excluded	IVA inclusa / VAT included
INOX 	137,7€	168€
CANNA FUCILE  PVD	186,88€	228€
ORO ROSA  PVD	186,88€	228€

KIT-SOFFITTO-SOFFIONE-LEVANTE-LUNGO-25

STOCK Ø25



 INOX 8025431155794

PVD  ORO-ROSA 8025431156890



PVD  CANNA-FUCILE 8025431159457

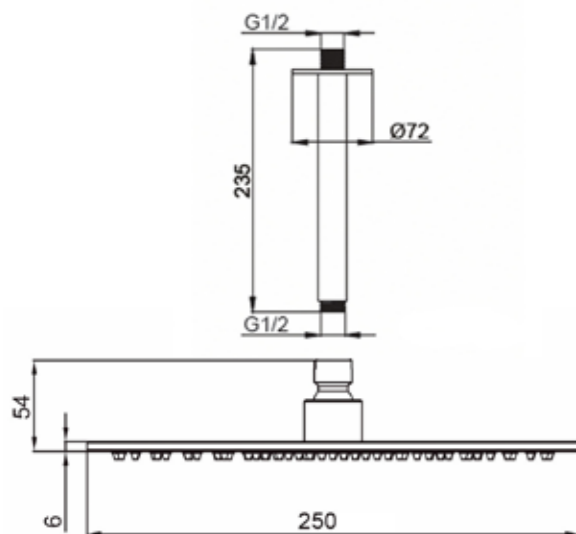

CARATTERISTICHE

- **MATERIALE ACCIAIO INOX 316L / 316L STAINLESS STEEL**
- **KIT DOCCIA A SOFFITTO CON SOFFIONE Ø25CM
CEILING SHOWER SET WITH Ø25CM SHOWER HEAD**
- **ADATTO AD AMBIENTI AD ALTA ESPOSIZIONE
SUITABLE FOR HIGH-EXPOSURE AREAS**
- **BORDO RINFORZATO SPESSORE 6 MM
REINFORCED EDGE, 6 MM THICKNESS**
- **UGELLI IN SILICONE ANTICALCARE
ANTI-LIME SILICONE NOZZLES**
- **COMPLETAMENTE PRIVO DI PIOMBO
COMPLETELY LEAD-FREE**
- **COMPONENTI KIT**
 1. BRACCIO-DOCCIA-SOFFITTO-LEVANTE-LUNGO
 2. SOFFIONE-LEVANTE-25
- **IDEALE PER STRUTTURE COME HOTEL, PISCINE PUBBLICHE, PALESTRE, AEROPORTI O BAGNI DI LOCALI CHE RICEVONO UN GRANDE FLUSSO DI UTENTI OGNI GIORNO
IDEAL FOR FACILITIES SUCH AS HOTELS, PUBLIC POOLS, GYMS, AIRPORTS, AND HIGH-TRAFFIC RESTROOMS EXPERIENCE CONSTANT DAILY USE**



finiture/finishes	IVA esclusa / VAT excluded	IVA inclusa / VAT included
INOX 	145,9€	178€
CANNA FUCILE  PVD	203,26€	248€
ORO ROSA  PVD	203,26€	248€

KIT-PARETE-SOFFIONE-LEVANTE-25

STOCK



 **INOX** 8025431155756

PVD  **ORO-ROSA** 8025431156142

PVD  **CANNA-FUCILE** 8025431159402

CARATTERISTICHE

- **MATERIALE ACCIAIO INOX 316L / 316L STAINLESS STEEL**
- **KIT DOCCIA A PARETE CON SOFFIONE Ø25CM**
WALL-MOUNTED SHOWER SET WITH Ø25 CM SHOWER HEAD
- **ADATTO AD AMBIENTI AD ALTA ESPOSIZIONE**
SUITABLE FOR HIGH-EXPOSURE AREAS
- **BORDO RINFORZATO SPESSORE 6 MM**
REINFORCED EDGE, 6 MM THICKNESS
- **UGELLI IN SILICONE ANTICALCARE**
ANTI-LIME SILICONE NOZZLES
- **COMPLETAMENTE PRIVO DI PIOMBO**
COMPLETELY LEAD-FREE

COMPONENTI SET



1. BRACCIO-DOCCIA-PARETE-LEVANTE
2. SOFFIONE-LEVANTE-25

- **PARTICOLARMENTE ADATTO PER AMBIENTI AD ALTO UTILIZZO O IN PROSSIMITÀ DEL MARE**
PARTICULARLY SUITABLE FOR HIGH-USE ENVIRONMENTS AND COASTAL AERAS

- **IDEALE PER STRUTTURE COME HOTEL, PISCINE PUBBLICHE, PALESTRE, AEROPORTI O BAGNI DI LOCALI CHE RICEVONO UN GRANDE FLUSSO DI UTENTI OGNI GIORNO**

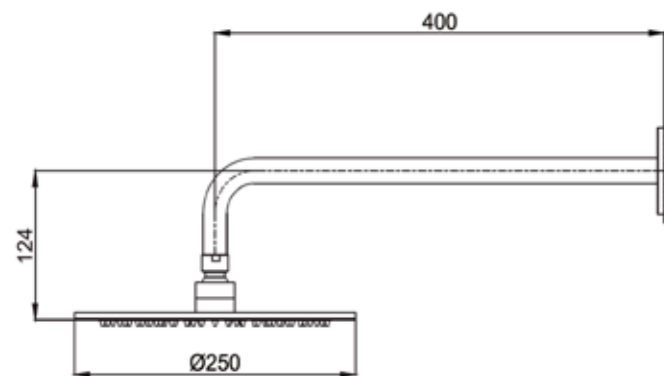
IDEAL FOR FACILITIES SUCH AS HOTELS, PUBLIC POOLS, GYMS, AIRPORTS, AND HIGH-TRAFFIC RESTROOMS EXPERIENCE CONSTANT DAILY USE



finiture/finishes	IVA esclusa / VAT excluded	IVA inclusa / VAT included
INOX 	154,1€	188€
CANNA FUCILE  PVD	211,47€	258€
ORO ROSA  PVD	211,47€	258€

KIT-SOFFITTO-SOFFIONE-LEVANTE-CORTO-30

STOCK Ø30



 **INOX** 8025431155831



PVD  **ORO-ROSA** 8025431156883

PVD  **CANNA-FUCILE** 8025431159440

CARATTERISTICHE

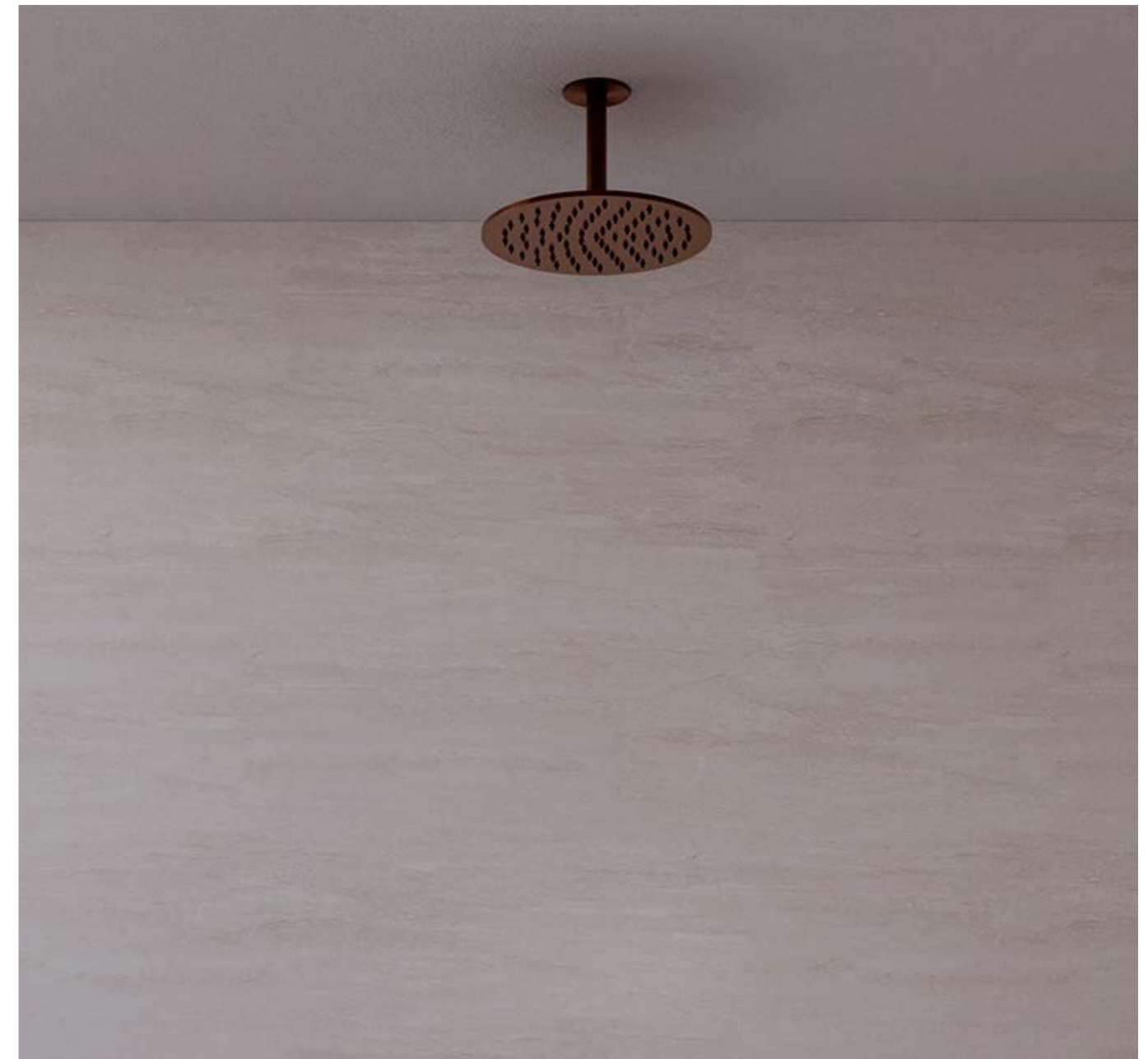
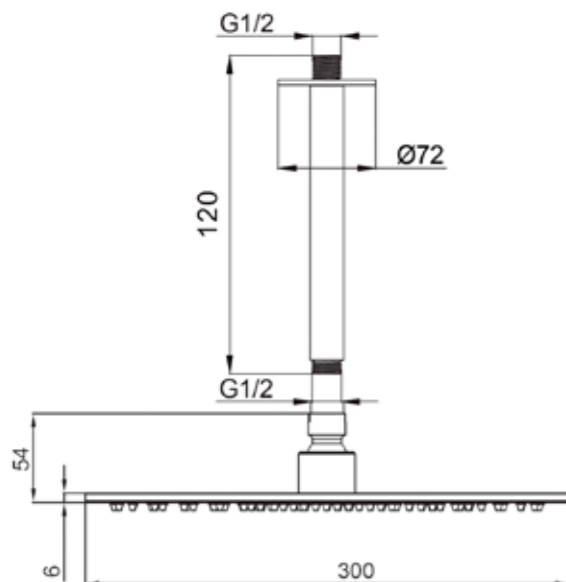
- **MATERIALE ACCIAIO INOX 316L / 316L STAINLESS STEEL**
- **KIT DOCCIA A SOFFITTO CON SOFFIONE Ø30 CM**
CEILING SHOWER SET WITH Ø30 CM SHOWER HEAD
- **ADATTO AD AMBIENTI AD ALTA ESPOSIZIONE**
SUITABLE FOR HIGH-EXPOSURE AREAS
- **BORDO RINFORZATO SPESSORE 6 MM**
REINFORCED EDGE, 6 MM THICKNESS
- **UGELLI IN SILICONE ANTICALCARE**
ANTI-LIME SILICONE NOZZLES
- **COMPLETAMENTE PRIVO DI PIOMBO**
COMPLETELY LEAD-FREE
- **COMPONENTI KIT**
 1. BRACCIO-DOCCIA-SOFFITTO-LEVANTE-CORTO
 2. SOFFIONE-LEVANTE-30
- **IDEALE PER STRUTTURE COME HOTEL, PISCINE PUBBLICHE, PALESTRE, AEROPORTI O BAGNI DI LOCALI CHE RICEVONO UN GRANDE FLUSSO DI UTENTI OGNI GIORNO**
IDEAL FOR FACILITIES SUCH AS HOTELS, PUBLIC POOLS, GYMS, AIRPORTS, AND HIGH-TRAFFIC RESTROOMS EXPERIENCE CONSTANT DAILY USE



finiture/finishes	IVA esclusa / VAT excluded	IVA inclusa / VAT included
INOX 	186,89€	228€
CANNA FUCILE  PVD	252,46€	308€
ORO ROSA  PVD	252,46€	308€

KIT-SOFFITTO-SOFFIONE-LEVANTE-LUNGO-30

STOCK Ø30



 **INOX** 8025431155794

PVD  **ORO-ROSA** 8025431156890



PVD  **CANNA-FUCILE** 8025431159457

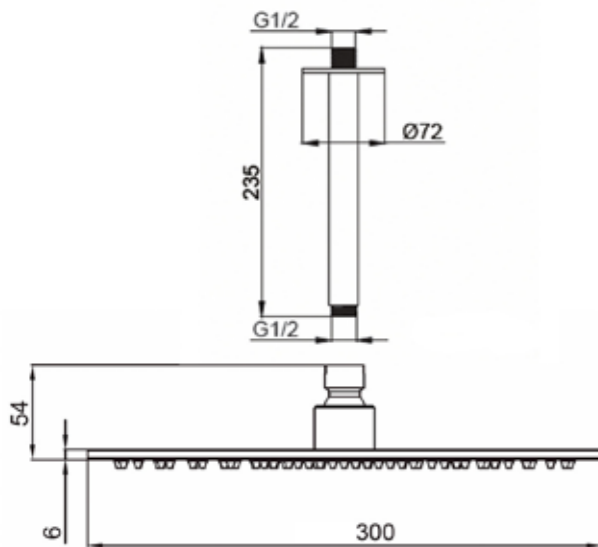

CARATTERISTICHE

- **MATERIALE ACCIAIO INOX 316L / 316L STAINLESS STEEL**
- **KIT DOCCIA A SOFFITTO CON SOFFIONE Ø30CM
CEILING SHOWER SET WITH Ø30CM SHOWER HEAD**
- **ADATTO AD AMBIENTI AD ALTA ESPOSIZIONE
SUITABLE FOR HIGH-EXPOSURE AREAS**
- **BORDO RINFORZATO SPESSORE 6 MM
REINFORCED EDGE, 6 MM THICKNESS**
- **UGELLI IN SILICONE ANTICALCARE
ANTI-LIME SILICONE NOZZLES**
- **COMPLETAMENTE PRIVO DI PIOMBO
COMPLETELY LEAD-FREE**
- **COMPONENTI KIT**
 1. BRACCIO-DOCCIA-SOFFITTO-LEVANTE-LUNGO
 2. SOFFIONE-LEVANTE-30
- **IDEALE PER STRUTTURE COME HOTEL, PISCINE PUBBLICHE, PALESTRE, AEROPORTI O BAGNI DI LOCALI CHE RICEVONO UN GRANDE FLUSSO DI UTENTI OGNI GIORNO
IDEAL FOR FACILITIES SUCH AS HOTELS, PUBLIC POOLS, GYMS, AIRPORTS, AND HIGH-TRAFFIC RESTROOMS EXPERIENCE CONSTANT DAILY USE**



finiture/finishes	IVA esclusa / VAT excluded	IVA inclusa / VAT included
INOX 	195,08€	238€
CANNA FUCILE  PVD	268,84€	328€
ORO ROSA  PVD	268,84€	328€

KIT-PARETE-SOFFIONE-LEVANTE-30

STOCK



 **INOX** 8025431155763

PVD  **ORO-ROSA** 8025431156159

PVD  **CANNA-FUCILE** 8025431159419



CARATTERISTICHE

- **MATERIALE ACCIAIO INOX 316L / 316L STAINLESS STEEL**
- **KIT DOCCIA A PARETE CON SOFFIONE Ø30CM**
WALL-MOUNTED SHOWER SET WITH Ø30 CM SHOWER HEAD
- **ADATTO AD AMBIENTI AD ALTA ESPOSIZIONE**
SUITABLE FOR HIGH-EXPOSURE AREAS
- **BORDO RINFORZATO SPESSORE 6 MM**
REINFORCED EDGE, 6 MM THICKNESS
- **UGELLI IN SILICONE ANTICALCARE**
ANTI-LIME SILICONE NOZZLES
- **COMPLETAMENTE PRIVO DI PIOMBO**
COMPLETELY LEAD-FREE



COMPONENTI SET



1. BRACCIO-DOCCIA-PARETE-LEVANTE
2. SOFFIONE-LEVANTE-30

- **PARTICOLARMENTE ADATTO PER AMBIENTI AD ALTO UTILIZZO O IN PROSSIMITÀ DEL MARE**
PARTICULARLY SUITABLE FOR HIGH-USE ENVIRONMENTS AND COASTAL AERAS

- **IDEALE PER STRUTTURE COME HOTEL, PISCINE PUBBLICHE, PALESTRE, AEROPORTI O BAGNI DI LOCALI CHE RICEVONO UN GRANDE FLUSSO DI UTENTI OGNI GIORNO**

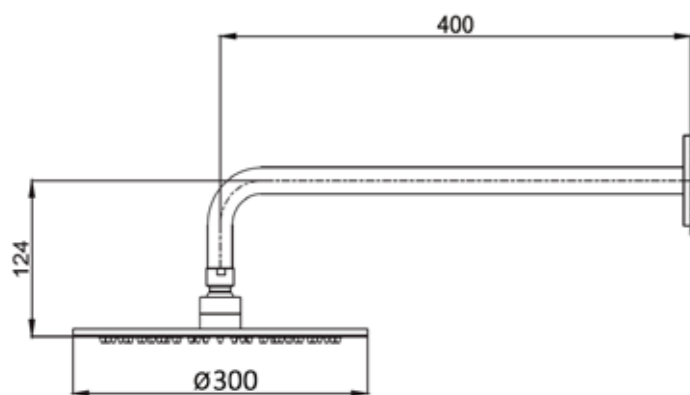
IDEAL FOR FACILITIES SUCH AS HOTELS, PUBLIC POOLS, GYMS, AIRPORTS, AND HIGH-TRAFFIC RESTROOMS EXPERIENCE CONSTANT DAILY USE



finiture/finishes	IVA esclusa / VAT excluded	IVA inclusa / VAT included
INOX 	203,28€	248€
CANNA FUCILE  PVD	277,05€	338€
ORO ROSA  PVD	277,05€	338€

Tutto in uno per un'esperienza completa



















I set doccia completi SINED in acciaio inossidabile AISI 316L riuniscono in un'unica soluzione tutti gli elementi necessari per un'esperienza doccia di livello superiore. Progettati per garantire la massima resistenza e durata, combinano soffione, doccetta e comandi in un insieme armonioso e funzionale. La loro estetica moderna e l'alta qualità li rendono la scelta ideale per progetti che ricercano design, comfort e affidabilità in ogni dettaglio.

All-in-one for a complete experience

SINED's complete shower sets, crafted from AISI 316L stainless steel, bring together all the essential elements for a superior showering experience in a single, integrated solution. Designed to ensure maximum strength and durability, they combine a shower head, hand shower and controls into a harmonious and functional whole. Their modern aesthetic and high quality make them the ideal choice for projects seeking design, comfort and reliability in every detail.



SET completo per doccia in acciaio inossidabile 316L
Complete 316L stainless steel shower SET

 KIT-DOCCIA-SOFFITTO-CORTO-25  INOX CANNA FUCILE  ORO ROSA	 KIT-DOCCIA-SOFFITTO-CORTO-30  INOX CANNA FUCILE  ORO ROSA	 KIT-DOCCIA-SOFFITTO-LUNGO-25  INOX CANNA FUCILE  ORO ROSA
 KIT-DOCCIA-SOFFITTO-LUNGO-30  INOX CANNA FUCILE  ORO ROSA	 KIT-DOCCIA-PARETE-25  INOX CANNA FUCILE  ORO ROSA	 KIT-DOCCIA-PARETE-30  INOX CANNA FUCILE  ORO ROSA

KIT-DOCCIA-SOFFITTO-CORTO-25

STOCK

 INOX 8025431159884

PVD  ORO-ROSA 8025431159891



PVD  CANNA-FUCILE 8025431159907



CARATTERISTICHE

- **MATERIALE ACCIAIO INOX 316L / 316L STAINLESS STEEL**
- **KIT COMPLETO DOCCIA A SOFFITTO CON SOFFIONE Ø25CM COMPLETE CEILING-MOUNTED SHOWER KIT WITH A 25CM SHOWER HEAD**
- **ADATTO AD AMBIENTI AD ALTA ESPOSIZIONE SUITABLE FOR HIGH-EXPOSURE AREAS**
- **UGELLI IN SILICONE ANTICALCARE ANTI-LIME SILICONE NOZZLES**
- **COMPLETAMENTE PRIVO DI PIOMBO COMPLETELY LEAD-FREE**
- **COMPONENTI SET**
 1. KIT-SOFFITTO-SOFFIONE-LEVANTE-CORTO-25
 2. DOCCETTA-FLESSIBILE-MURO-LEVANTE
 3. MISCELATORE-MURO-LEVANTE
 4. DEVIATORE-MURO-LEVANTE
- **PARTICOLARMENTE ADATTO PER AMBIENTI AD ALTO UTILIZZO O IN PROSSIMITÀ DEL MARE PARTICULARLY SUITABLE FOR HIGH-USE ENVIRONMENTS AND COASTAL AERAS**
- **IDEALE PER STRUTTURE COME HOTEL, PISCINE PUBBLICHE, PALESTRE, AEROPORTI O BAGNI DI LOCALI CHE RICEVONO UN GRANDE FLUSSO DI UTENTI OGNI GIORNO IDEAL FOR FACILITIES SUCH AS HOTELS, PUBLIC POOLS, GYMS, AIRPORTS, AND HIGH-TRAFFIC RESTROOMS EXPERIENCE CONSTANT DAILY USE**



finiture/finishes	IVA esclusa / VAT excluded	IVA inclusa / VAT included
INOX 	548,36€	669€
CANNA FUCILE  PVD	723,75€	882,99€
ORO ROSA  PVD	723,75€	882,99€

KIT-DOCCIA-SOFFITTO-LUNGO-25



STOCK

 INOX 8025431159945



PVD  ORO-ROSA 8025431159952

PVD  CANNA-FUCILE 8025431159969

CARATTERISTICHE

- **MATERIALE ACCIAIO INOX 316L / 316L STAINLESS STEEL**
- **KIT COMPLETO DOCCIA A SOFFITTO CON SOFFIONE Ø25CM COMPLETE CEILING-MOUNTED SHOWER KIT WITH A 25CM SHOWER HEAD**
- **ADATTO AD AMBIENTI AD ALTA ESPOSIZIONE SUITABLE FOR HIGH-EXPOSURE AREAS**
- **UGELLI IN SILICONE ANTICALCARE ANTI-LIME SILICONE NOZZLES**
- **COMPLETAMENTE PRIVO DI PIOMBO COMPLETELY LEAD-FREE**
- **COMPONENTI SET**
 1. KIT-SOFFITTO-SOFFIONE-LEVANTE-LUNGO-25
 2. DOCCETTA-FLESSIBILE-MURO-LEVANTE
 3. MISCELATORE-MURO-LEVANTE
 4. DEVIATORE-MURO-LEVANTE
- **PARTICOLARMENTE ADATTO PER AMBIENTI AD ALTO UTILIZZO O IN PROSSIMITÀ DEL MARE PARTICULARLY SUITABLE FOR HIGH-USE ENVIRONMENTS AND COASTAL AERAS**
- **IDEALE PER STRUTTURE COME HOTEL, PISCINE PUBBLICHE, PALESTRE, AEROPORTI O BAGNI DI LOCALI CHE RICEVONO UN GRANDE FLUSSO DI UTENTI OGNI GIORNO IDEAL FOR FACILITIES SUCH AS HOTELS, PUBLIC POOLS, GYMS, AIRPORTS, AND HIGH-TRAFFIC RESTROOMS EXPERIENCE CONSTANT DAILY USE**



finiture/finishes	IVA esclusa / VAT excluded	IVA inclusa / VAT included
INOX 	556,56€	679€
CANNA FUCILE  PVD	740,13€	902,96€
ORO ROSA  PVD	740,13€	902,96€

KIT-DOCCIA-PARETE-25

STOCK

 **INOX** 8025431159822

PVD  **ORO-ROSA** 8025431159839

PVD  **CANNA-FUCILE** 8025431159846

PVD  **NERA** 8025431020269 *

PVD  **ORO** 8025431020276*

*DISPONIBILE SOLO SU ORDINAZIONE

*AVAILABLE ONLY UPON REQUEST

CARATTERISTICHE

- **MATERIALE ACCIAIO INOX 316L / 316L STAINLESS STEEL**
- **KIT COMPLETO DOCCIA A PARETE CON SOFFIONE Ø25CM COMPLETE WALL-MOUNTED SHOWER KIT WITH A 25CM SHOWER HEAD**
- **ADATTO AD AMBIENTI AD ALTA ESPOSIZIONE SUITABLE FOR HIGH-EXPOSURE AREAS**
- **UGELLI IN SILICONE ANTICALCARE ANTI-LIME SILICONE NOZZLES**
- **COMPLETAMENTE PRIVO DI PIOMBO COMPLETELY LEAD-FREE**





COMPONENTI SET

1. KIT-PARETE-SOFFIONE-LEVANTE-25
2. DOCCETTA-FLESSIBILE-MURO-LEVANTE
3. MISCELATORE-MURO-LEVANTE
4. DEVIATORE-MURO-LEVANTE

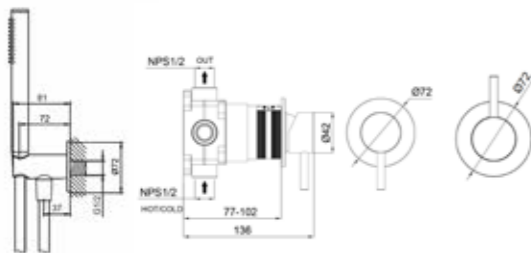
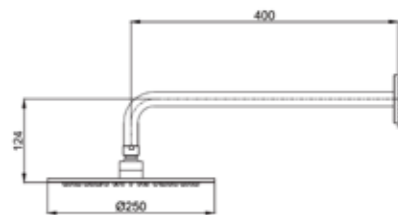
- **PARTICOLARMENTE ADATTO PER AMBIENTI AD ALTO UTILIZZO O IN PROSSIMITÀ DEL MARE PARTICULARLY SUITABLE FOR HIGH-USE ENVIRONMENTS AND COASTAL AERAS**

- **IDEALE PER STRUTTURE COME HOTEL, PISCINE PUBBLICHE, PALESTRE, AEROPORTI O BAGNI DI LOCALI CHE RICEVONO UN GRANDE FLUSSO DI UTENTI OGNI GIORNO IDEAL FOR FACILITIES SUCH AS HOTELS, PUBLIC POOLS, GYMS, AIRPORTS, AND HIGH-TRAFFIC RESTROOMS EXPERIENCE CONSTANT DAILY USE**



finiture/finishes	IVA esclusa / VAT excluded	IVA inclusa / VAT included
INOX 	564,75€	689€
CANNA FUCILE  PVD	748,34€	912,99€
ORO ROSA  PVD	748,34€	912,99€
ORO*  PVD	748,34€	912,99€
NERO*  PVD	748,34€	912,99€

* Disponibile solo su richiesta / Available only upon request

KIT-DOCCIA-SOFFITTO-CORTO-30



STOCK

 INOX 8025431159914



PVD  ORO-ROSA 8025431159921

PVD  CANNA-FUCILE 8025431159938

CARATTERISTICHE

- **MATERIALE ACCIAIO INOX 316L / 316L STAINLESS STEEL**
- **KIT COMPLETO DOCCIA A SOFFITTO CON SOFFIONE Ø30CM COMPLETE CEILING-MOUNTED SHOWER KIT WITH A 30CM SHOWER HEAD**
- **ADATTO AD AMBIENTI AD ALTA ESPOSIZIONE SUITABLE FOR HIGH-EXPOSURE AREAS**
- **UGELLI IN SILICONE ANTICALCARE ANTI-LIME SILICONE NOZZLES**
- **COMPLETAMENTE PRIVO DI PIOMBO COMPLETELY LEAD-FREE**
- **COMPONENTI SET**
 1. KIT-SOFFITTO-SOFFIONE-LEVANTE-CORTO-30
 2. DOCCETTA-FLESSIBILE-MURO-LEVANTE
 3. MISCELATORE-MURO-LEVANTE
 4. DEVIATORE-MURO-LEVANTE
- **PARTICOLARMENTE ADATTO PER AMBIENTI AD ALTO UTILIZZO O IN PROSSIMITÀ DEL MARE PARTICULARLY SUITABLE FOR HIGH-USE ENVIRONMENTS AND COASTAL AERAS**
- **IDEALE PER STRUTTURE COME HOTEL, PISCINE PUBBLICHE, PALESTRE, AEROPORTI O BAGNI DI LOCALI CHE RICEVONO UN GRANDE FLUSSO DI UTENTI OGNI GIORNO IDEAL FOR FACILITIES SUCH AS HOTELS, PUBLIC POOLS, GYMS, AIRPORTS, AND HIGH-TRAFFIC RESTROOMS EXPERIENCE CONSTANT DAILY USE**



finiture/finishes	IVA esclusa / VAT excluded	IVA inclusa / VAT included
INOX 	597,54€	729€
CANNA FUCILE  PVD	789,33€	962,99€
ORO ROSA  PVD	789,33€	962,99€

CONDIZIONI DI FORNITURA

Crediamo nella qualità e nella durata dei nostri prodotti. Per questo motivo, offriamo una garanzia di 3 anni su tutti i prodotti a marchio SINED.

1. INFORMAZIONI GENERALI

Garanzia del Produttore

- Per “Consumatore” si intende qualsiasi persona fisica o giuridica che sia proprietaria del prodotto e non lo abbia acquistato per rivenderlo o installarlo a terzi nell’esercizio di un’attività commerciale o professionale.
- Per “Cliente Iniziale” o “Rivenditore” si intende il primo acquirente di prodotti a marchio SINED, sia esso un rivenditore o un professionista che rivende o installa il prodotto per terzi nell’ambito della propria attività.

2. PERIODO DI GARANZIA

Il periodo di garanzia decorre dalla data di acquisto indicata sulla fattura originale del Cliente Iniziale (Rivenditore).

La garanzia ha una durata di **3 anni** a partire dalla suddetta data, a condizione che:

- La fattura originale venga conservata e mostrata su richiesta;
- Il prodotto sia stato installato e mantenuto da personale qualificato, secondo le istruzioni e le normative in vigore.

3. GARANZIA

Per attivare una richiesta di assistenza in garanzia il Consumatore deve:

- Notificare per iscritto il difetto a SINED o al Rivenditore autorizzato;
- Presentare la fattura originale che dimostri la data di acquisto e la validità della garanzia;
- Assicurarsi che l’installazione e la manutenzione siano state effettuate da personale qualificato.

4. LIMITAZIONI DELLA GARANZIA

La garanzia **non copre**:

- Parti soggette a normale usura (cartucce, guarnizioni, anelli di tenuta, pompe sapone, filtri, aeratori);
- Danni da installazione errata o da presenza di residui nelle tubature tipo sabbia o calcare.
- Danni causati da sporcizia, calcare, uso improprio, prodotti chimici aggressivi, errori di funzionamento, urti, agenti atmosferici o ambienti estremi.

5. DECADENZA DELLA GARANZIA

La garanzia **decade** nei seguenti casi:

- Danni causati da forza maggiore (es. incendi, inondazioni, gelo);
- Uso improprio o non conforme alle istruzioni d’uso;
- Installazione, manutenzione o riparazioni effettuate da personale non qualificato;
- Utilizzo di ricambi non originali SINED;
- Deterioramento da calcare, sovratensioni elettriche, fenomeni atmosferici;
- Manutenzione inadeguata o mancata osservanza delle istruzioni;

Interventi non coperti:

- Pulizia filtri;
- Pulizia aeratori;
- Rimozione del calcare da doccette, soffioni o superfici.

In caso di reclami **non fondati** (difetti non imputabili a SINED), **tutti i costi** (accertamento, trasporto, manodopera) saranno addebitati al cliente.

6. ESCLUSIONI E COSTI A CARICO DEL CONSUMATORE

Se il difetto non è coperto dalla garanzia:

- I costi di spedizione/trasporto sono a carico del Consumatore;
- Se il Consumatore desidera comunque effettuare la riparazione, dovrà farsi carico dei costi di ricambi e manodopera.

La garanzia **non è rinnovabile e non prevede risarcimenti** per danni diretti o indiretti derivanti da guasti o difetti del prodotto.

7. DISPOSIZIONI FINALI

La presente garanzia:

- È trasferibile al futuro proprietario del prodotto solo se Consumatore;
- È soggetta alla legge **italiana**.

SUPPLY CONDITIONS

We believe in the quality and durability of our products. For this reason, we offer a 3-year warranty on all SINED brand products.

1. GENERAL INFORMATION

Manufacturer’s Warranty

- “Consumer” means any natural or legal person who owns the product and has not purchased it to resell or install it to third parties in the course of a commercial or professional activity.
- “Initial Customer” or “Reseller” means the first purchaser of SINED brand products, whether a reseller or a professional who resells or installs the product for third parties in the course of their business.

2. WARRANTY PERIOD

The warranty period runs from the date of purchase indicated on the original invoice of the Initial Customer (Reseller).

The warranty lasts for **3 years** from that date, provided that:

- The original invoice is retained and shown upon request;
- The product has been installed and maintained by qualified personnel, according to the instructions and regulations in force.

3. WARRANTY

To activate a warranty service request, the Consumer must:

- Notify the defect in writing to SINED or the Authorized Dealer;
- Present the original invoice demonstrating the date of purchase and the validity of the warranty;
- Ensure that installation and maintenance have been carried out by qualified personnel.

4. WARRANTY LIMITATIONS

The warranty **does not cover**:

- Parts subject to normal wear (cartridges, gaskets, sealing rings, soap pumps, filters, aerators);
- Damage from incorrect installation or the presence of residues in the pipes such as sand or limescale.
- Damage caused by dirt, limescale, improper use, aggressive chemicals, operating errors, impacts, atmospheric agents or extreme environments.

5. WARRANTY VOID

The warranty **lapses** in the following cases:

- Damage caused by force majeure (e.g. fires, floods, frost);
- Improper use or use not in accordance with the instructions for use;
- Installation, maintenance or repairs carried out by unqualified personnel;
- Use of non-original SINED spare parts;
- Deterioration from limescale, electrical surges, atmospheric phenomena;
- Inadequate maintenance or failure to follow the instructions;

Interventions not covered:

- Filter cleaning;
- Cleaning aerators;
- Removing limescale from shower heads, shower heads or surfaces.

In the event of **unfounded complaints** (defects not attributable to SINED), **all costs** (assessment, transport, labour) will be charged to the customer.

6. EXCLUSIONS AND COSTS TO BE PAID BY THE CONSUMER

If the defect is not covered by the warranty:

- Shipping/transport costs are to be paid by the Consumer;
- If the Consumer still wishes to carry out the repair, he will have to pay the costs of spare parts and labour.

The warranty **is not renewable and does not provide compensation** for direct or indirect damages resulting from faults or defects of the product.

7. FINAL PROVISIONS

This warranty:

- Is transferable to the future owner of the product only if a Consumer;
- Is subject to **Italian law**.



SINED Ventas Online
S.L.



Via Trajana 50-56
Nave 28, Sant Martí,
08020 Barcelona

Polígono industrial de
Montsolís

 **SINED**

ITALIA:

**M.P. C.
Musso Personal Computer Srl
Via Beatrice d'Este 24
20122 Milano, Italia
IT11811400156**

ESPAÑA:

Oficina, showroom y logística:

**Sined Ventas Online S.L.
Vía Trajana 50-56 Nave 28, Sant Martí,
08020 Barcelona
ESB42784397**

TELEFONO IT +39 02 21117815
MOBILE IT +39 335 7600875
MOBILE EN/FR +39 3425447140
TELÉFONO ES +34 664 66 64 26
TELÉFONO ES +34 664 66 64 28
TELÉFONO ES +34 661 102 712
CENTRALITA ES +34 935 05 67 23

INFO@SINEDITALIA.COM

SINEDITALIA.COM
SINEDITALIA.IT
SINEDITALIA.ES
SINEDITALIA.FR